



TVD2002-B 20" CRT TV / DVD COMBO
Colour Television



OPERATION MANUAL

**Please read these instructions carefully
Before operating this product**

INTRODUCTION

Thank you for purchasing our product. To ensure that you fully understand the capabilities of this television set, please read this entire manual carefully, and keep it handy for future reference.

INSTALLATION

- Locate the TV set in a room where direct light does not reflect on the screen. Total darkness or a reflection on the picture screen can cause eye strain. Soft and indirect lighting is recommended for comfortable viewing.
- Allow enough space between the TV set and the wall to permit ventilation. Avoid excessively warm locations to prevent possible damage to the cabinet or premature component failure.
- Never connect this TV set to DC supply or any other power supply than the one indicated in SPECIFICATIONS section.
- Do not install the TV set in a location near heat sources such as a radiator, air ducts, and direct sunlight or in a closed area without proper ventilation.
- Do not cover the ventilation openings when using the TV set.

CAUTION

Never tamper with any components inside the set or adjust any controls other than those mentioned in this manual. All television receivers are high voltage instruments and the tube is manufactured using a vacuum process. If the tube is broken, glass fragments will be violently expelled. Scratching or chipping of the tube is dangerous and should be avoided. When cleaning the television ensure the set is unplugged and use only a dry soft cloth to remove the dust. During a thunder storm unplug both the power cord and aerial plug to protect the set from damage. Only a qualified technician should attempt any adjustments or repairs inside the television.

IMPORTANT SAFETY INFORMATION

WARNING: TO PREVENT FIRE OR SHOCK HAZARD, DO NOT EXPOSE THIS APPLIANCE TO RAIN OR MOISTURE.



The lightning flash with arrowhead symbol, within an equilateral triangle is intended to alert the user to the presence of uninsulated dangerous voltage within the product's enclosure that may be of sufficient magnitude to constitute a risk of electric shock.



The exclamation point within an equilateral triangle is intended to alert the user to the presence of important operating and maintenance (servicing) instructions in the literature accompanying the appliance.

**CLASS I
LASER PRODUCT**

Specifications

TV Section	
Receiving channels	181 channels tuner (Frequency synthesized tuning))
Colour-System	NTSC
Sound-System	M
DVD Section	
Laser Wave Length	655nm
Laser Power:	Class 1
Signal System	NTSC output
Support Format:	DVD/HDVD/VCD/SVCD/CD/MP3

General Section	
AC Power input	AC 120V 50/60Hz
AC Power Consumption	90W
Audio Output	2 Speakers of 5W each
Dimensions	500X470X455MM
Net Weight	20KG
Infra-red Remote Control	
Features	Full function remote control
Effective Distance Power	8 metres
Power Supply	DC 3V (2X1.5V, size AAA)

Note: Design & Specifications are subject to change without prior notice.

Style 3

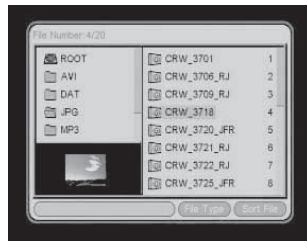
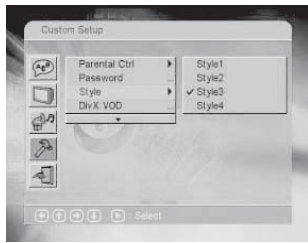

Style 4

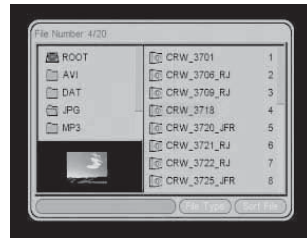
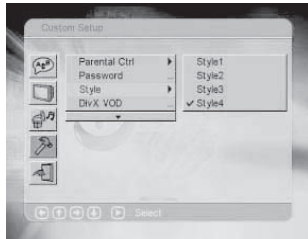

4.4 Angle Mark

When the DVD disc supports multiple angles, turn on this function, system will show the counts of angle and current angle code at the screen bottom.



4.5 Default

When user select 'Read', press ENTER key SETUP will return default status.

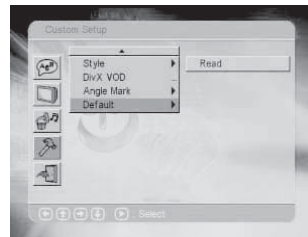

5. Exit Setup Mode

When user select 'Exit Setup Mode', press ENTER key can go back to playing states as well as pressing SETUP key.

IMPORTANT SAFEGUARDS

- 1. READ INSTRUCTIONS**
All the safety and operating instructions should be read before the unit is operated.
- 2. RETAIN INSTRUCTIONS**
The safety and operating instructions should be retained for future reference.
- 3. HEED WARNINGS**
All warnings on the unit and in the operating instructions should be adhered to.
- 4. FOLLOW INSTRUCTIONS**
All operating and use instructions should be followed.
- 5. CLEANING**
Unplug this unit from the wall outlet before cleaning. Do not use liquid cleaners or aerosol cleaners.
- 6. ATTACHMENTS**
The manufacturer of this unit does not make any recommendations for attachments, as they may cause hazards.
- 7. WATER AND MOISTURE**
Do not use this unit near water. For example, near a bathtub, washbowl, kitchen sink, laundry tub, in a wet basement, or near a swimming pool.
- 8. ACCESSORIES**
Do not place this unit on an unstable cart, stand, tripod, bracket, or table. The unit may fall, causing serious injury and serious damage to the unit.

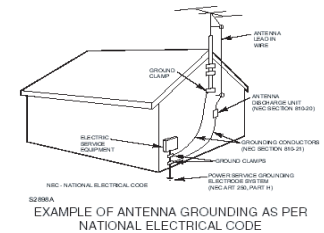
An appliance and cart combination should be moved with care. Quick stops, excessive force, and uneven surfaces may cause the appliance and cart combination to overturn.
- 9. VENTILATION**
Slots and openings in the cabinet back or bottom are provided for ventilation, and to ensure reliable operation of the unit, and to protect it from overheating. These openings must not be blocked or covered; the openings should never be blocked by placing the unit on a bed, sofa, rug, or other similar surface. This unit should never be placed near or over a radiator or heat source. This unit should not be placed in a built-in installation such as a bookcase or rack unless proper ventilation is provided or the manufacturer's instructions have been adhered to.
- 10. POWER SOURCE**
This unit should be operated only from the type of power source indicated on the rating plate. If you are not sure of the type of power supply to your home, consult your appliance dealer or local power company. For units intended to operate from battery power, or other sources, refer to the respective pages in this User Manual for their operating instructions.
- 11. GROUNDING OR POLARIZATION**
This unit is equipped with a polarized alternating current line plug (plug having one blade wider than the other). This plug will fit into the power outlet only one way. This is a safety feature. If you are unable to insert the plug fully into the outlet, try reversing the plug. If the plug should still fail to fit, contact your electrician to replace your obsolete outlet. Instead of the polarized alternating-current line plug, your unit may be equipped with a 3-wire grounding-type plug (a plug having a third grounding pin). This plug will only fit into a grounding-type power outlet. This too, is a safety feature. If you are unable to insert the plug into the outlet, contact your electrician to replace your obsolete outlet. Do not defeat the safety purpose of the grounding-type plug.
- 12. POWER-CORD PROTECTION**
Power-supply cords should be routed so that they are not likely to be walked on or pinched by items placed upon or against them, paying particular attention to cords at plugs, convenience receptacles, and the point where they exit from the appliance.
- 13. LIGHTNING**
To protect your unit from a lightning storm, or when it is left unattended and unused for long periods of time, unplug it from the wall outlet and disconnect the antenna or cable system. This will prevent damage to the unit due to lightning and power line surges.
- 14. POWER LINES**
An outside antenna system should not be located in the vicinity of overhead power lines or other electric light or power circuits, or where it can fall onto or against such power lines or circuits. When installing an outside antenna system, extreme care should be taken to keep from touching such power lines or circuits, as contact with them might be fatal.
- 15. OVERLOADING**
Do not overload wall outlets and extension cords, as this can result in a risk of fire or electric shock.
- 16. OBJECT AND LIQUID ENTRY**
Do not push objects through any openings in this unit, as they may touch dangerous voltage points or short out parts that could result in fire or electric shock. Never spill or spray any type of liquid into the unit.
- 17. OUTDOOR ANTENNA GROUNDING**
If an outside antenna or cable system is connected to the unit, be sure the antenna or cable system is grounded to provide some protection against voltage surges and built-up static charges. Section 8 10 of the National Electrical Code (NEC), ANSI/NFPA 70, provides information with respect to proper grounding of the mast and supporting structure, grounding of the lead-in wire to an antenna discharge unit, size of grounding conductors, location of antenna discharge unit, connection to grounding electrodes, and requirements for the grounding electrode. See figure below.



18. SERVICING

Do not attempt to service this unit yourself as opening or removing covers may expose you to dangerous voltage or other hazards. Refer all servicing to qualified service personnel.

19. DAMAGE REQUIRING SERVICE

Unplug this unit from the wall outlet and refer servicing to qualified service personnel under the following conditions:

- When the power-supply cord or plug is damaged.
- If liquid has been spilled, or objects have fallen into the unit.
- If the unit has been exposed to rain or water.
- If the unit does not operate normally by following the operating instructions. Adjust only those controls that are covered by the operating instructions, as an improper adjustment of other controls may result in damage and will often require extensive work by a qualified technician to restore the unit to its normal operation.
- If the unit has been dropped or the cabinet has been damaged.
- When the unit exhibits a distinct change in performance, this indicates a need for service.

20. REPLACEMENT PARTS

When replacement parts are required, be sure the service technician uses replacement parts specified by the manufacturer or those that have the same characteristics as the original part. Unauthorized substitutions may result in fire, electric shock or other hazards.

21. SAFETY CHECK

Upon completion of any service or repairs to this unit, ask the service technician to perform safety checks to determine that the unit is in proper operating condition.

22. HEAT

The product should be situated away from heat sources such as radiators, heat registers, stoves, or other products (including amplifiers) that produce heat.

23. CONNECTING

When you connect the product to other equipment, turn off the power and unplug all of the equipment from the wall outlet. Failure to do so may cause an electric shock and serious personal injury. Read the owner's manual of the other equipment carefully and follow the instructions when making any connections.

24. NOTE TO CABLE TV SYSTEM INSTALLER

This reminder is provided to call the Cable TV system installer's attention to Article 820-40 of the NEC that provides guidelines for proper grounding and, in particular, specifies that the cable ground shall be connected to the grounding system of the building, as close to the point of cable entry as practical.

25. DISCONNECTING

To disconnect the main POWER, you must unplug the power cord from the AC outlet. The power switch DOES NOT completely disconnect power.

THE CAUSES OF INTERFERENCE

Incorporated in your TV set is the most up-to-date technology to eliminate interference. Local radiation however, can create disturbances which in turn, can noticeably affect the picture. Proper installation and a good antenna are your best safeguards against these disturbances.

Interference

Moving ripples across the screen are caused by nearby transmitting or receiving shortwave radio equipment.

Diathermy

Herringbone pattern and partial picture loss can result from the operation of diathermy equipment from a nearby medical center or hospital.

Snow

Weak TV signals from long distant stations result in an unsteady picture and give the effect of falling snow. An antenna adjustment or antenna amplifier may be needed.

Ghost

Multiple images caused by TV signals reflected back from surrounding buildings, hills, aircraft, etc. are minimized by proper antenna positioning.

Car Ignition

Nearby cars and electrical motors can cause small streaks across the picture or make the picture roll.

4. Custom Setup

4.1 Parental Control

It needs password to enter this function (system default password is 8888), after verifying the password and screen will change as follow figure, there are 8 levels, Number 8 can play all restricted videos, The smaller number, the more restrictions, or to select 'Off' to disable this function.

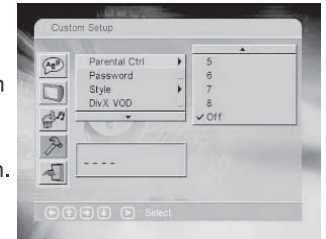

4.2 Password

Please input old password, first. (If first time to change password, system default value is 8888), and then input your new password, and then input your password again to verify to avoid the input password mistakes.

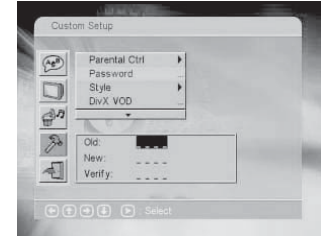

4.3 Style

This function allows to let user set the style of user manual, there is four styles as below:

Style 1

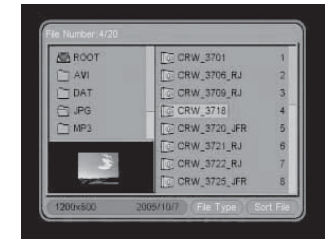
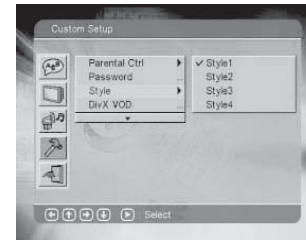

Style 2

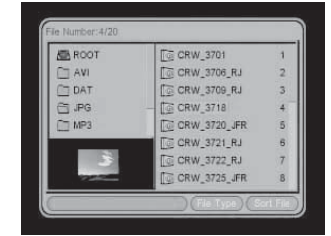
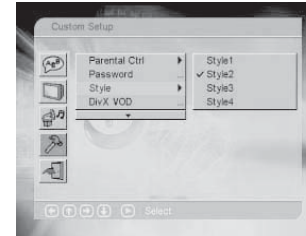

2.3 TV System

There are three selection for TV System: NTSC . User can according to its TV system to select. If the TV to support both of NTSC, PAL, we also can select AUTO item and the system can identify automatically.



2.4 Video Output

It supports CVBS+S-VIDEO



2.5 Brightness

There are 3 kinds of brightness, including 'Normal' 、 'Bright' 、 'Soft' .



2.6 Contrast

From -4 to +4, 0 as normal, user can select by his preference.

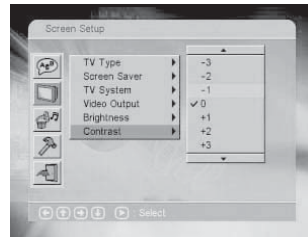

3. Audio Setup

3.1 Downmix

'DownMix' has 2 options, one is Lo / Ro ,another is Lt /Rt.



Location of Control

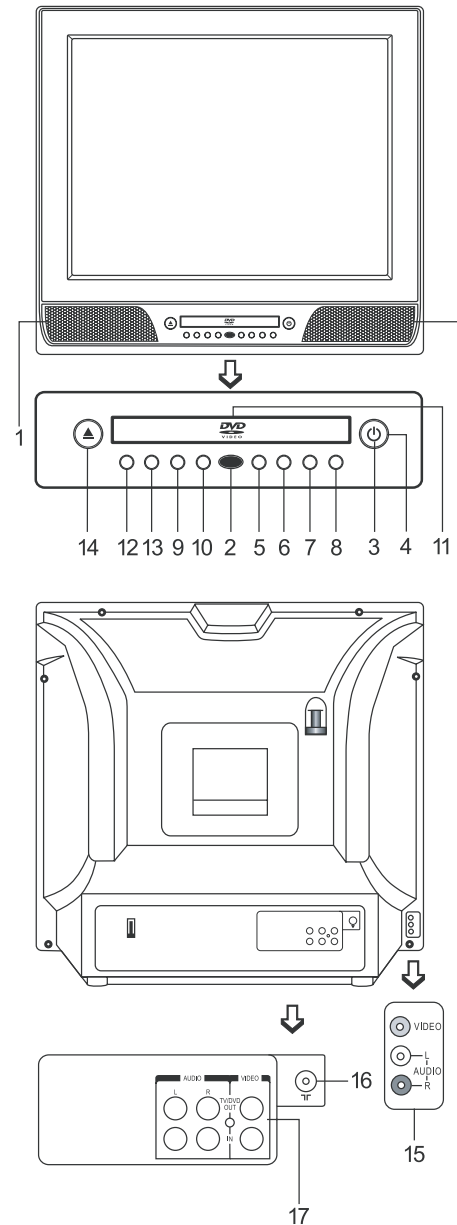

1. Speaker
2. Remote Sensor
3. Standby Indicator
4. Power Button
5. Volume Down Button (V-)
6. Volume Up Button (V+)
7. Channel Down Button (P-)
8. Channel Up Button (P+)
9. TV/AV/DVD Button
10. MENU Button
11. DVD Loader
12. Play/Pause(▶||) Button
13. Stop(■) Button
14. Open/Close(▲) Button
15. Side A/V in
16. 75 ohm Antenna socket
17. Rear A/V in, Rear A/V out for TV or DVD (Optional)

Remote Control Unit

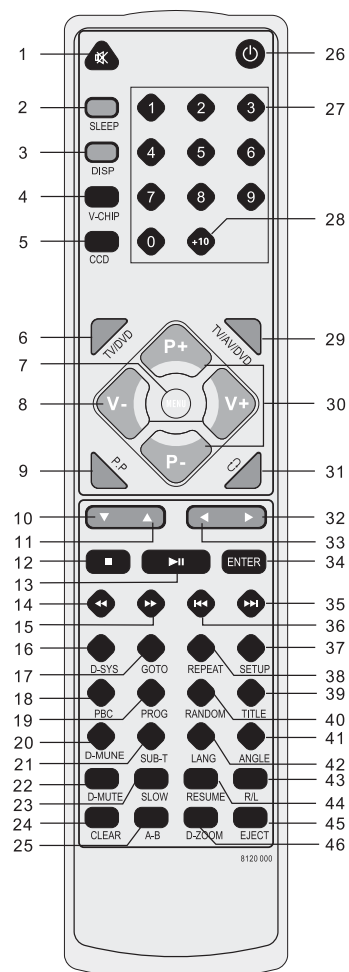

1. Mute Button
2. Sleep Button
3. DISP Button
4. V-CHIP Button
5. CCD Button
6. TV/DVD Button
7. TV Menu Button
8. Volume (+/-) Button
9. P.P Button
10. Down Button (▼)
11. Up Button (▲)
12. Stop Button (■)
13. Play/Pause Button (▶||)
14. Search Backward Button (◀◀)
15. Search Forward Button (▶▶)
16. DVD System Button
17. Goto Button
18. PBC Button
19. Program Button
20. D-MUNE Button
21. Subtitle Button
22. D-Mute Button
23. Slow Button
24. Clear Button
25. A-B Button
26. Standby Button
27. Numeric Buttons
28. Double Digit Button
29. TV/AV/DV/D Button
30. TV Program (+/-) Button
31. Program Return Button (◀)
32. Right Button (▶)
33. Left Button (◀)
34. Enter Button
35. Skip Forward Button (▶▶)
36. Skip Backward Button (◀◀)
37. Setup Button
38. Repeat Button
39. Title Button
40. Random Button
41. Angle Button
42. Language (DVD) Button
43. R/L Button
44. Resume Button
45. EJECT Button
46. D-ZOOM Button

Battery Installation

Insert two pcs of “AAA” batteries as illustrated and replace the battery cover.

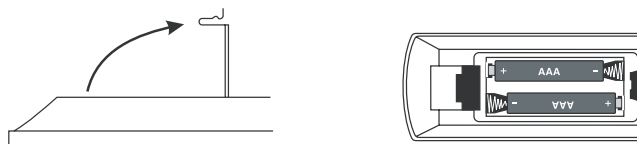

language\Audio language\Subtitle language, it has different effect, or it will not change after finishing setting.

Total eight kinds of OSD language: English \ French \ German \ Italian \ Spanish \ Portuguese \ Dutch \ Polish.

1.2 Menu

This is to select the SETUP DVD menu language. Menu appear 13 kinds of languages, including English \ Chinese \ Japanese \ French \ German \ Italian \ Spanish \ Portuguese \ Indian \ Thai \ Russian \ Korean \ Others. If the DVD Disc support SETUP menu language, system will play the corresponding menu language, if DVD disc doesn't support SETUP menu language, system will select first menu language in disc automatically.



1.3 Audio

This is to select the SETUP audio language. audio language appears 13 kinds of languages, including English \ Chinese \ Japanese \ French \ German \ Italian \ Spanish \ Portuguese \ Indian \ Thai \ Russian \ Korean \ Others. If the DVD Disc supports SETUP audio language, system will play the corresponding audio language, if DVD disc doesn't support SETUP audio language, system will select first audio language in disc automatically.



1.4 Subtitle language

This is to select the SETUP subtitle language. "Subtitle language" appears 14 kinds of languages, including English \ Chinese \ Japanese \ French \ German \ Italian \ Spanish \ Portuguese \ Indian \ Thai \ Russian \ Korean \ Others \ OFF. If the DVD Disc supports SETUP subtitle language, system will play the corresponding audio language, if DVD disc doesn't support SETUP subtitle language, system will select first subtitle language in disc automatically.



1.5 External Subtitle language

Can select WESTERN EUROPEAN or CENTRAL EUROPEAN language.

2. Screen Setup.

2.1 TV Type

TV Type: there are three types, including '4:3 Ps' '4:3 LB' '16:9'

2.2 Screen saver ON or OFF

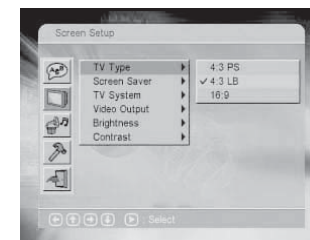

D-Zoom

- The Zoom function allows you to enlarge or zoom out the video image and to pan through the image. Press D-Zoom repeatedly to activate the function and choose the required zoom factor: x1,x2,x4

Note: This feature does not work when the Disc Menu appears.

- Use the Arrow buttons to pan across the screen when the zoom factor is x1,x2,x4

Goto

You can use Search feature to select a title / chapter / track number or go to a specific point in a title. Firstly, press Search (Goto) button on the remote controller to bring up the search menu and enter the edit state; Secondly, press Arrow buttons to highlight the title / chapter / track number or the time option; Thirdly, use Numeric buttons to enter the title / chapter / track you want to play or the elapsed time you want to go to in that title; At last, press Enter button to start playback.

Note:

- This feature does not work in Program Play mode.
- If PBC is on, it will turn off automatically when Search Play starts.
- When playing MP3 / JPEG discs, Search Feature does not work.

Freeze Frame and Frame Advance

- During CD, CD-G, HD-CD, DTS-CD or MP3 / JPEG playback, press Pause once to freeze playback; Press the Pause button again or Play button to resume normal playback.
- During DVD, SVCD or VCD playback, press Pause once to freeze playback; Press of the Pause button again to advance the picture one frame at a time; Press Play to resume normal playback.

DVD Set-up Menu Operation

When the system is at stop status, APress SETUP key to enter SETUP menu. There are 4 options, including LANGUAGE SETUP, SCREEN SETUP, AUDIO SETUP, CUSTOMER SETUP, we can use ▼▲▶◀key and ENTER key to modify setting, and set value will refresh directly right now. When screen show dialog, press SETUP key or ◀ key will return to parental menu; In other status, Press SETUP key will exit SETUP menu.

1. Language setup

1.1 OSD

This is to select the SETUP DVD OSD language, For example: We want to let SETUP menu become be as English, after entering language setup, let cursor move to OSD language item, system will show eight languages to provide user to select. If we move cursor to English and press ENTER key, all menu will change as English right now. If disc supports different function in Menu



Notes:

- Use only the size and type of batteries specified.
- Do not mix different types of batteries together or old batteries with fresh ones.
- Remove the batteries when remote control will not be used for a long period of time.
- Avoid direct sunlight, incandescent lamp, fluorescent lamp or any other strong light shines on batteries.
- Do not try to recharge batteries; they are not intended to be recharged.
- Do not drop, dampen or disassemble the remote control.
- When the batteries are about to wear out, the remote control may be unstable.
- Do not throw the batteries into a fire; dispose of used batteries in the specified manner.

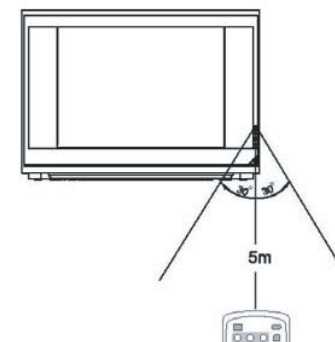

Effective Range of the

POWER ON/OFF

To Switch the TV Set On and OFF

1. Plug the power cord into the power socket.
2. Then Press the main POWER, power LED lights up at standby mode.
3. Press the Power switch on Remote control.



Notes:

- Please unplug the AC cord when you may not use the unit for an extend period of time.

SELECTING INPUT SIGNAL

Watching AV program

This TV set provides AV input terminals for your convenient connection to VCR, or other video equipments. To watch video program from AV inputs, press TV/DVD OR TV/AV/DVD button repeatedly until you see the appropriate input indicator on the screen.



Notes:

- *AV1:* Select AV1 when viewing the signals from the video equipment connected to the AV1 IN terminals.
- *AV2:* Select AV2 when viewing the signals from the video equipment connected to the AV 2 IN terminals.
- *DVD:* Select "DVD" when viewing the signals from the built-in DVD

Press TV/DVD signal switch between TV and DVD
Press TV/AV/DVD, signal switch as TV→AV1→AV2→DVD→TV

TUNING IN

TV/CATV selection

Before your TV can memorize the available channels, you must specify the type of signal source that is connected to the unit (i.e., an antenna or cable system):

1. Press MENU repeatedly to display Search menu.
2. Press P- or P+ to select Signal Input.
3. Press V- or V+ to select Air or CATV.
4. Press DISP button to clear the menu screen.



Notes:

- *Select Air if using VHF/UHF antenna, select CATV if using Cable TV.*

Setting the channels into memory

This TV is equipped with a channel memory feature which allows channels to skip up or down to the next channel set into memory, skipping over unwanted channels. Before selecting channels, they must be programmed into the TV's memory.

1. Press MENU repeatedly to display Search menu.
2. Press P- or P+ to select Auto Search.
3. Press V+ to start the search. (The TV will begin memorizing all the channels available in your area.)

To skip unwanted channel

After presetting the channels, you can skip unwanted channels so that only the channels you want to watch can be accessed with Channel up/down buttons.

1. Press MENU button repeatedly to display Search menu.
2. Press P- or P+ to select Channel menu item.

from centre vertical, extend to centre horizontal, extend to centre vertical, window horizontal, window vertical, wipe from edge to centre, move in from top.

- When a picture is playing or pausing, press the Arrow buttons to change the display angle:
 - Up: Invert / Normal
 - Down: Mirror / Normal
 - Left: Rotate
 - Right: Rotate
- The Stop button is used to display thumbnail pictures while picture display. After it is enabled, up to twelve scaled-down thumbnail pictures will be displayed on the screen. The Skip Backward and Skip Forward buttons can be used to display the PREVIOUS and NEXT twelve pictures in the current directory. Each of the twelve pictures are numbered from 1-12. By pressing a number button, the corresponding picture will be enlarged to fill most of your TV screen and the digest mode will be cancelled.

Color System

Press the D-SYS button on the handset to display current TV system. Press the button again to change to the next TV system. With each consecutive press of the D-SYS button, the TV system switches. If you press the button four times, the TV system cycles back.

Language Selection

During disc playback, press the LANG button once on the remote control, and the audio language info banner appears.

When a DVD is recorded with multiple soundtracks, you can use the Language feature to temporarily change the audio language (the language of the soundtrack).

Title Play

- During DVD playback, press the Title button to display the DVD title content.
- Press the Arrow buttons to highlight the title you want to choose, and press Enter. Also you can press number buttons to choose.
- The DVD player begins with the chapter 1 of the chosen title.

D-MUTE

Press the button cuts out sound from the player, press the button again to restore the previous sound level, and to cancel the mute.

Random

- Press the Random button the first time, the MP3/CD/VCD/DVD will enter Random Play status.
- Press the button the second time, the MP3/CD/VCD/DVD will enter Disorder Play status.
- Press the button the third time, the MP3/CD/VCD/DVD will enter Sequence Play status.

PBC

- When playing the VCD over edition 1.1, it can be changed to PBC function.
- When PBC is off, you can not select Tracks or Chapter Play through the content picture, it will be played in order only or you can select by pressing the Last or Next button.
- When PBC is on, you can select Tracks or Chapter Play through the content picture.

- When playing MP3 / JPEG discs, press Number buttons to select different tracks on current track list.

Note: To select tracks from 1 to 10, press corresponding Number buttons (1-9, 0). To select tracks above 10, press +10 button. For example, to select the track 15, first press +10 button, then press 5 button. If the selected track is not available, the input would be invalid.

Playing MP3 Discs

1. Insert an Mp3 CD, the DVD video player will initialize the disc when the tray is closed and the directory (folder) will be shown in an Mp3 MENU on screen.
2. Press Up or Down button to select the folder you want play, then press Right button to enter the folder. Press Up or Down button to select mp3 songs and press Enter button to play.
3. Press Skip Backward or Skip Forward button during playback to skip the tracks, press Search Backward or Search Forward button during playback to fast revers or fast forward.

Note:

- “  ” sign in front of a file name indicates that this is a folder, not a MP3 file.
- “ MP3 ” sign in front of a file name indicates that this is a MP3 file.
- During MP3 playback, you can access to “PLAY MODE” folder or songs by pressing REPEAT button
- You can press the Number buttons to select the file you want to play. For example, if you desire the 15th track in current list, press 1 button once, then press 5 button, and press Enter button, the 15th starts playback.
Note: When playing a disc with MP3 file, video cannot be output while only digital audio can.

Playing JPEG Discs

1. Insert an JPEG CD, the DVD video player will initialize the disc when the tray is closed and the directory (folder) will be shown in an JPEG MENU on screen.
2. Press Up or Down button to select the folder you want play, then press Right button to enter the folder. Press Up or Down button to select JPEG picture and press Enter button to play.
3. To view the Next or Previous picture press the Skip Backward or Skip Forward button.

Note:

- When playing a JPEG picture, press the Program button to select the pictures switched mode. There are 15 switch modes; Press Program repeatedly to activate the function and choose the required switch mode: wipe from top to bottom, wipe from bottom to top, wipe from left to right, wipe from right to left, diagonal wipe right top, diagonal left bottom, diagonal right bottom, extend from centre horizontal, extend

3. Press V- or V+ to select the unwanted channel.
4. Press P- or P+ to select Skip.
5. Press V- or V+ to select Skip ON.

Thus, after exiting the menu, the channel will then be skipped when you select programs with the Channel up/down button. If you want to skip other unwanted channels, repeat steps above to change the channel number.



Notes:

- You can select the skipped channel by pressing the direct channel select buttons.

To restore a skipped channel

Use direct channel select buttons (0-9) to select the channel you want to restore. Enter into Search menu, press P- or P+ to select Skip, press V- or V+ to select Skip Off.

Fine Tuning

Fine tuning is not necessary under normal conditions. However, in area of inferior broadcast conditions where adjustment is necessary for a better picture and sound, use Fine tuning.

1. Select the channel you want to fine-tune.
2. Enter into Search menu, press P- or P+ to select Fine Tune,
3. Press and hold V- or V+, the channel begins fine tuning until the best possible picture and sound is achieved. (Press V- to fine-tune downward, while V+ to fine-tune upward. The AFT function will be set to OFF mode automatically)
4. To exit the menu, press DISP button or repeatedly press MENU button.

Auto Fine Tuning (AFT)

If picture and sound's effect of the channel is instead poor by making use of Fine Tune, you can correct them by making use of AFT. Enter into Search menu, press P- to select AFT then press V- or V+ to select AFT On.

CHANNEL SELECTION

You can select your desired TV program by one of the following methods.

Use Direct Channel Select buttons

▶ AIR Mode Direct Channel Selection

When the Signal Input menu option in Search menu is in the Air position, all channels can be selected by directly entering the channel number.

▶ CATV Mode Direct Channel Selection

When the Signal Input menu option in Search menu is in the CATV position, channels can be selected as follows:

Method 1:

Directly enter the channel number and wait for some time.

Method 2:

1-9: Press “0” twice, then 1-9 as needed. For example, to select channel 2, press “002”.

10-99: Press “0”, then the remaining 2 digits. For example, to select channel 12, press “012”.

100-125: Press the 3 digits in order. For example, to select channel 120, press “120”.

Use Channel up/down buttons

Press P+ button, the channel number increases; Press P- button, the channel number decreases.

Use previous channel button

Press  button to switch between the current channel and the previous one.

Use **DISP** button to know the current channel number

Press DISP button to display the current TV state. If in TV program 12 ST SAP viewing, then it will display the current channel number, sound mode and remaining sleep time (if set).

PICTURE ADJUSTMENT

To select the picture mode

You can select the picture quality instantly among three preset modes and one user-set mode.

Press P.P button to select the desired picture quality. Standard, Dynamic, Mild and User (user-set) can be selected cyclically.

Mode	Picture quality
Standard	Display normal pictures
Dynamic	Display dynamic pictures
Mild	Display soft pictures
User	The picture quality you set

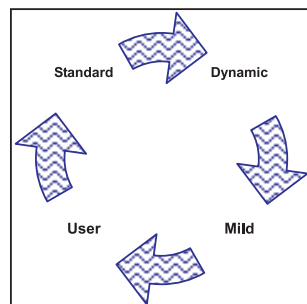

Picture adjustment

1. Press MENU button to display the Picture menu.
2. Press P+ or P- to select item.
3. Press V+ or V- to adjust the level
4. To exit the menu, press the DISP button

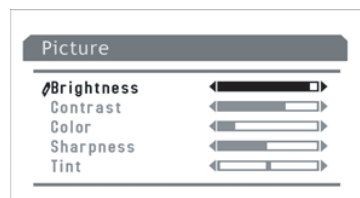

Item	V-	V+
Brightness	darker	lighter
Contrast	weaker	stronger
Color	paler	deeper
Sharpness	softer	sharper
*Tint	purplish	greenish

Notes:

- The adjusted level is stored in the User position.

A-B

- During the normal or fast motion playback, press the A-B button once, and “⌚ A” will appear on the screen. This indicates the start of the loop to be repeated.
- During the normal of fast motion playback, press A-B again, and “⌚ AB” will appear on the screen. It indicates the end of the loop.
 - Looping will run from set point A to set point B until you turn off Repeat.
- Press A-B again to cancel A-B loop mode.
 - When playing a S-VCD, VCD or CD disc, you can repeat a specific segment only in one track. When the next track begins, A-B Repeat turns off automatically.
 - When playing a DVD disc, you can repeat a specific segment only in one title/chapter.

Note: Number of subtitle available depends on the DVD disc.

Angle

Some discs may have multiple viewing angles during production. Use the ANGLE button to select the viewing angle shown on the screen.

Note: The number of Angle of view depends on the disc.

Resume Play

This function is available for DVD and CD audio. During playback, when the STOP button is pressed once, the player will enter the Resume Play mode. At this time, if the PLAY button is pressed, the player will resume playback at the location where the STOP button is

pressed. If the STOP button is pressed a second time, resume mode will be cancelled.

R/L(Changing the Soundtrack)

Press the R/L button to display current soundtrack.

- Press the button can switch soundtracks.
- Press the button again on the handset to turn to next soundtrack.
 - When playing a SVCD or VCD disc, there are five soundtracks: Stereo (L/R), L/L, R/R, L/L Auto A/D Detect, and R/R Auto A/D Detect. With each consecutive press of the button, the soundtrack switches. If you press the button six times, soundtrack cycles back to Stereo.
 - When playing a CD, CD-G, DTS-CD, HD-CD or MP3 disc, there are three audio output options: Stereo (L/R), L/L and R/R.

Note:

- Switch to L/L Auto A/D Detect or R/R Auto A/D Detect to have various antistrophes (you can have an antistrophe with the singing on the disc, according to the contents on the disc).
- When playing a dual-language VCD movie disc, press the L/R button to select the desired language.

Program Play(DVD and VCD)

The Program Playback option allows you to enter the order in which you want chapters or tracks to play. Press the PROGRAM button.

DVD Player Operation

Basic DVD Operation

Turn On the TV and your DVD Player

To select the DVD player press the TV/AV/DVD button on the TV or the TV/DVD or TV/AV/DVD button on the handset. The screen will now show a DVD logo and Loading will also appear, providing a disc is in the player. If there is no disc in the player it will display No disc. If there is a disc in the player it will automatically begin to load.

Play discs

1. Press the **▲** (OPEN/CLOSE) button on the TV or press the EJECT on the handset, and Open appears on the screen, then place a disc gently into the tray with the disc's label facing up (double-sided discs have content on the both sides, so you can place either side up), and press the **▲** (OPEN/CLOSE) or EJECT button again to close the disc tray, Close appears and the player starts to read, Then the disc starts playing automatically.
2. Press the STOP button if you want to stop the Disc playback You can resume playback by pressing the PLAY button and it will start at the location where you have pressed stopped (Resume Play).
3. Press the STOP button twice to clear the disc "Memory" and the disc will stop fully.

Play /Pause (▶||)

This function is applicable for DVD and CD audio.

- For DVD, the picture will freeze.
- For CD audio, it will become muted

1. Press the (▶||) button to pause play.
2. Press the (▶||) button again to resume Play.

Search Backward (◀◀) / Search Forward(▶▶)

This function is applicable for DVD and CD audio but with different effects. The SEARCH FORWARD button and SEARCH BACKWARD button are used to achieve fast play function.

- For DVD, there are 5 different levels of speed (2x, 4x, 8x, 16x, 32x) available. Press the SEARCH BACKWARD / SEARCH FORWARD button to cycle speed.
- For CD audio, the FORWARD/BACKWARD will play at high speed.

Note: Press PLAY button at any stage to resume to normal speed.

Skip Backward(◀◀) / Skip Forward(▶▶)

During playback, press one of the SKIP BACKWARD / SKIP FORWARD buttons.

- When the SKIP BACKWARD button is pressed once, playback returns to the beginning of the previous playing chapter or track.
- When the SKIP FORWARD button is pressed once, playback starts at the beginning of next chapter or track.

Slow

The Slow Forward is only available for DVD. There are 6 steps of slow motion speed; 1 / 2, 1 / 4, 1 / 8, 1 / 16, 1/32. Press the button to cycle playback speeds.

NOTE: Press the PLAY button to resume normal playback speed.

Repeat Mode

This function is applicable for DVD and CD audio but with different effects.

- For DVD disc playback, user can choose to repeat the current chapter, the current title or all. Press the REPEAT button can change between these three options.
- For CD, user can choose to repeat the current track or the whole disc (Repeat All). Press the REPEAT button can change between these two options.

SOUND CONTROLS

Adjusting Volume

1. Use Volume up/down button
2. Press V- button, the volume decreases; Press V+ button, the volume increases.
3. Make use of Sound menu to adjust volume
4. Press MENU twice to display Sound menu, then make use of V+/-button to adjust the level.

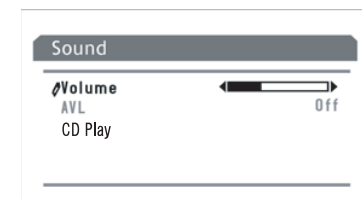

Use MUTE button

Press MUTE button on the remote control to cut off the sound from TV. To resume the sound, press this button again.

TIMER SETTING

Setting clock time

Making use of this function can set the current time for the TV.

1. Press MENU repeatedly to display the Timer menu.
2. Press P- or P+ to select Clock.
3. Press V- to set the hour (1-12), press V+ to set the minute (00-59).

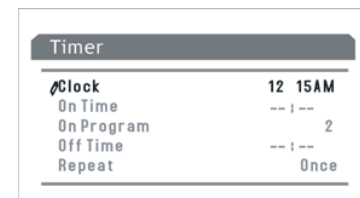

Notes:

- Before setting the ON timer and OFF timer, please set the Clock item first.

Setting ON timer/ON program

With the ON timer, the TV will automatically turn on to a preset channel at a preset time.

1. In Timer menu, press P- or P+ to select On Time.
2. Press V- to set the hour (1-12), press V+ to set the minute (00-59).
3. Press P- to select On Program.
4. Press V- or V+ to set the TV ON
5. Press P- to select Repeat; Press V- or V+ to select Once or Everyday.
6. Press **!** button to switch the TV to standby mode. At the preset time, the TV will turn on automatically to the preset channel. If you set the Repeat item to Once, this function effects only once; If set to Everyday, this function effects everyday.

Setting OFF timer

With the OFF timer, the TV will automatically switch to standby mode at a preset time.

1. In Timer menu, press P- or P+ to select Off Time.
2. Press V- to set the hour (1-12), press V+ to set the minute (00-59).
3. Press P- to select Repeat. Press V- or V+ to select Once or Everyday.
4. Once the preset time has elapsed, the TV will automatically go into standby mode.
5. If you set the Repeat item to Once, this function effects only once; If set to Everyday, this function effects everyday.

Setting sleep timer

Making use of the Sleep timer function allows you to have the set automatically turn off after a preset time. For example, if you would like the TV to auto turn off in 120 minutes, you can press sleep button repeatedly until the screen displays the desired amount of time. If you want to cancel the sleep timer, you can press sleep button repeatedly until 0 displays on the screen. See below:

0 → 120 → 90 → 60 → 50 → 40 → 30 → 20 → 15 → 10 → 5 → 0

SYSTEM SETTINGS

To select OSD language

There are multi OSD languages in this TV set provided for you to select (OSD: on-screen display)

1. Press MENU repeatedly to display Settings menu.
2. Press P+/- to select Language.
3. Press V+ or V- to select a proper OSD language.

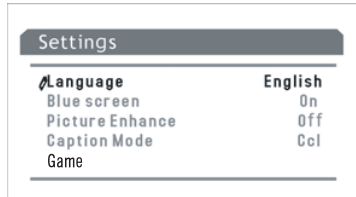

Setting Blue Screen

If the Blue Screen is turned on, the TV will appear a blue screen when there is no input signal.

1. Enter into Settings menu.
2. Press P- or P+ to select Blue Screen.
3. Press V+ or V- to turn on/off blue screen.

Picture Enhance setup

Turning on Picture Enhance can enhance the picture quality.

1. Enter into Settings menu.
2. Press P- or P+ to select Picture Enhance.
3. Press V+ or V- to turn on/off Picture Enhance.
4. To exit the menu, press DISP button or repeatedly press MENU button.
5. To exit GAME, press DISP button.

CLOSED CAPTIONS

You may select between CC1, CC2, CC3, CC4, T1, T2, T3 and T4.

The Closed Caption broadcasts can be viewed in two modes: CAPTION and TEXT. For each mode, four channels are available.

The [CAPTION] mode shows subtitles of dialogues and commentaries of TV dramas and news programs while allowing a clear view of the picture.

The unit decodes and displays the closed captions that are broadcast with certain TV shows. These captions are usually subtitles for the hearing impaired or foreign language translations. All VCRs record the closed caption signal from television programs, so home-recorded video tapes also provide closed captions. Most prerecorded commercial video tapes provide closed captions as well.

Notes: Not all the programs and videos will offer closed captioning.

Display Button

- Press the DISP button to display the current information of the TV, i.e. Channel.

Program Return Button ↔

- Press the button, the program can be interchanged between present program and former program.

TV Program (+/-) Button

- Press the P+ or P- button to select a higher or lower program number.

V-CHIP Button

- Press V-CHIP, See below:

parental control

Password: -----

U.S.TV Rating

MPAA Rating

CANADA English

CANADA French

Change Password

Import formerly Password 000000,

carry through correlative item operate.

TROUBLESHOOTING GUIDE

Should this unit exhibit a problem, check the following before seeking service:

Symptoms	Solution	Try different channel, if it is okay, it is probably a station trouble	Check aerial connections on back of set	Check aerial for broken wires	Re-orient aerial (if indoor type)	Probably local interference, such as an appliance	Adjust fine tuning control	Adjust brightness control	Adjust contrast control	Check if station is broadcasting in colour	Adjust colour control	Check if system switch is correct	Check if on/off switch is on	Check Batteries in Remote control
No picture, no sound	•	•	•				•							
Poor sound, picture OK	•				•	•	•						•	
Poor picture, sound OK	•	•	•	•	•	•	•	•						
Weak picture	•	•	•	•	•		•						•	
Blurred picture	•			•	•		•						•	
Double image	•	•	•	•			•							
Lines in picture	•			•	•	•	•							
Distorted picture	•			•	•		•						•	
Weak reception of some channels	•	•	•	•	•	•	•						•	
Horizontal lines in picture				•	•									
Picture rolls vertically	•			•	•		•						•	
Poor colour	•	•	•	•	•		•	•	•		•	•	•	
No colour in picture	•	•	•	•			•			•	•	•		
Erratic performance from remote control														•
Remote Control does not work														•
On Screen Display control outside the screen												•		